

Above Ground Pool- Perimeter Bonding

- Bonding done to conform to E42042 Code Standard
- #8 Solid Copper Wire
- Connected at 4 Points around Pool with Approved Hardware

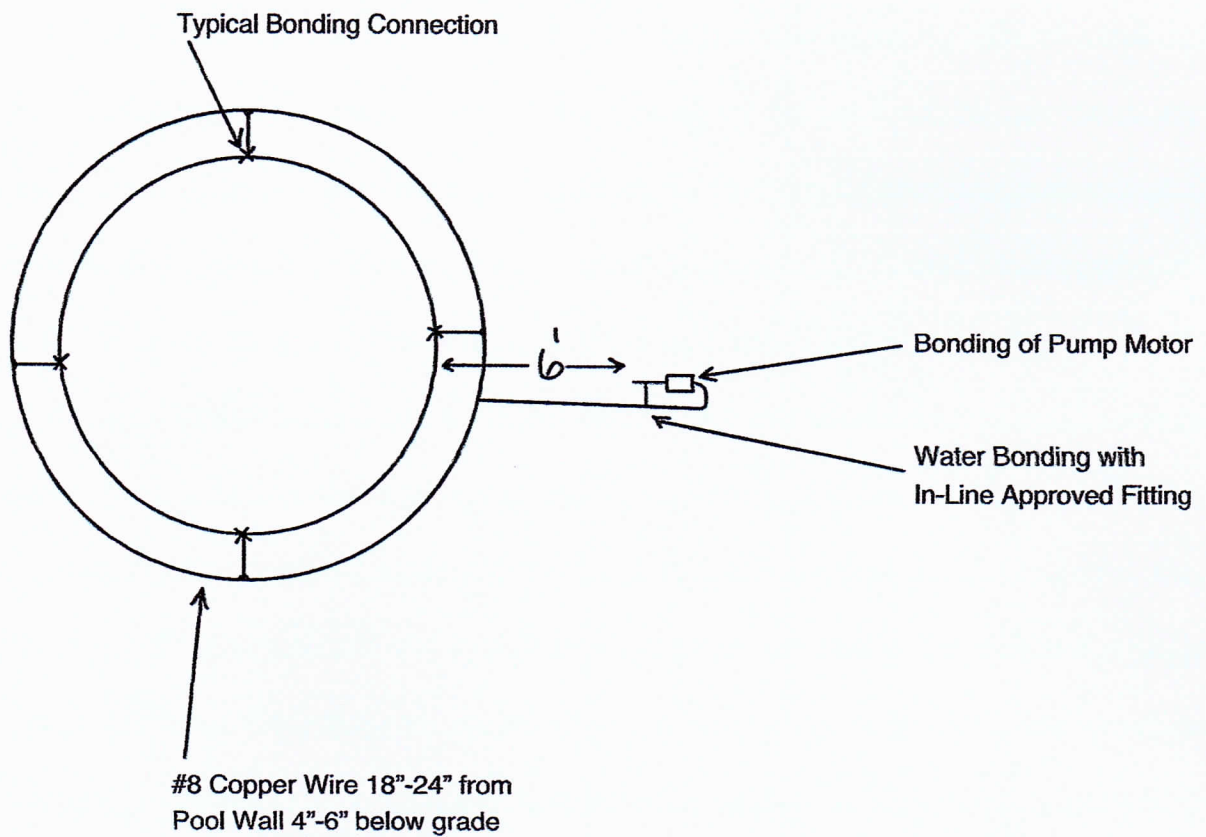

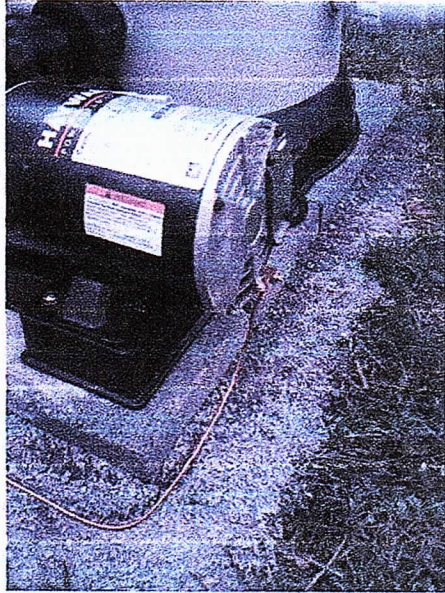

Bonding Pump Motor

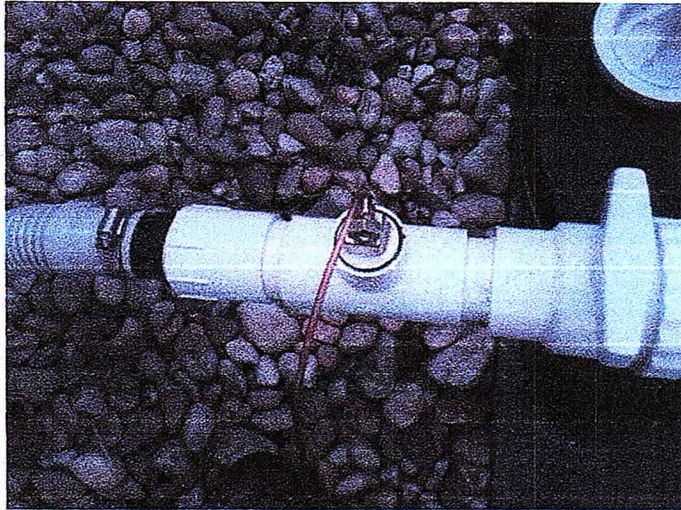

Water Bonding Fitting Installed

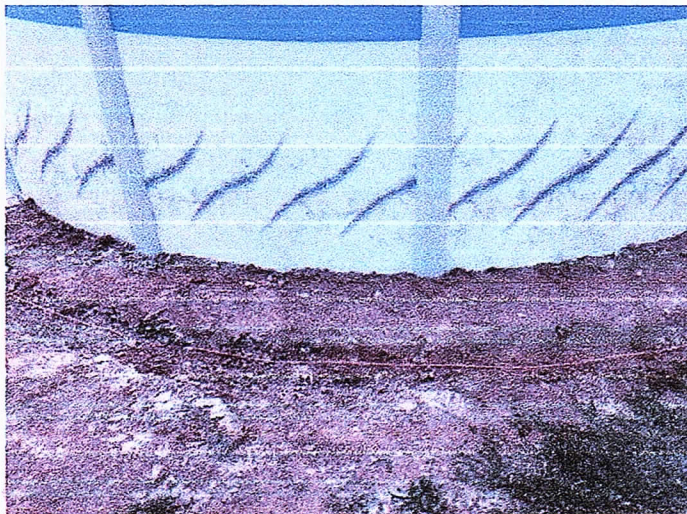

Wire 18-24 inches from Pool Wall 4-6 inches below grade

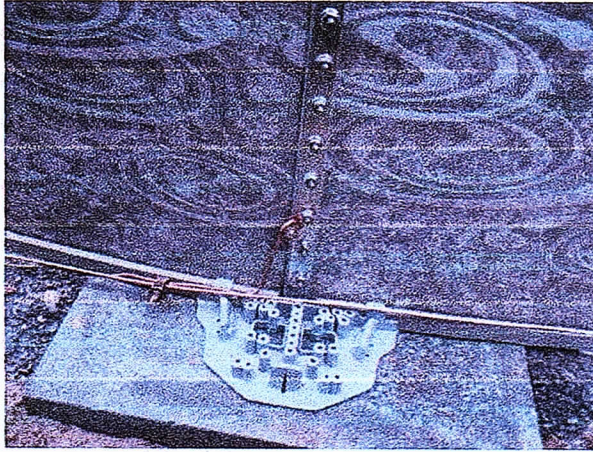

Bonding at Wall Seam

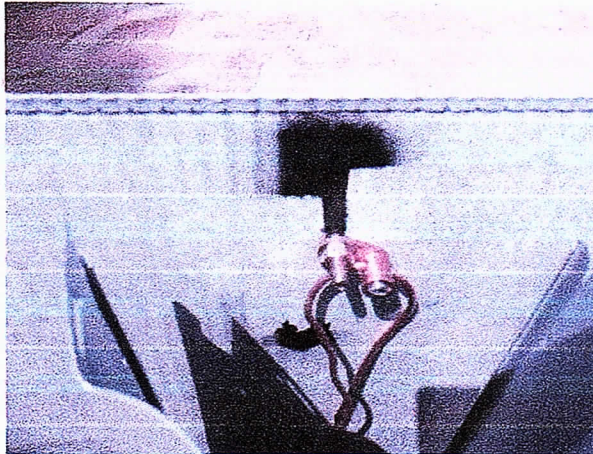

Bonding Connection not at Wall Seam

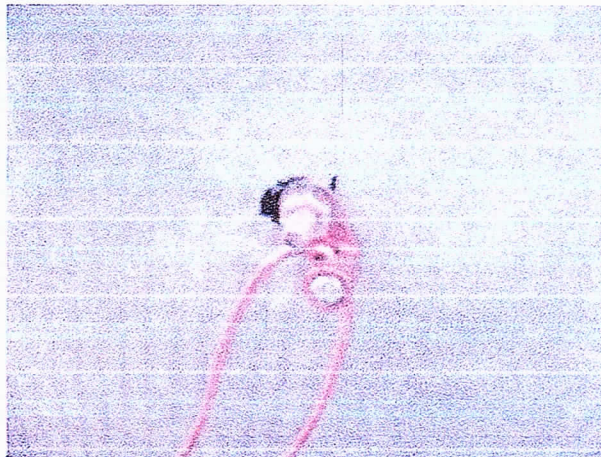

L70 Terminal Lug Bolted to Wall

POOLBOND

BY



THE 2008 NATIONAL ELECTRICAL CODE (NEC) REQUIRES THAT AN INTENTIONAL ELECTRICAL BOND BE MADE TO THE POOL WATER. THIS REQUIREMENT IS SPELLED OUT IN SECTION 680.26(C) OF THE NEC. THIS REQUIREMENT COVERS BOTH INGROUND AND ABOVE GROUND POOLS, SPAS, AND FOUNTAINS.

PASS ELECTRICAL INSPECTION WITH POOLBOND

POOLBOND PB-2008

- PREMIUM CORROSION RESISTANT BRONZE CASTING
- 1" MALE PIPE THREADS PROVIDES DIRECT INSTALLATION TO YOUR POOL, SPA, AND FOUNTAIN PLUMBING
- 10.5 SQUARE INCHES OF SURFACE AREA CONTACTS THE POOL WATER
- SPLIT BOLT LUG PROVIDES EASY & RELIABLE CONNECTION TO BONDING WIRE

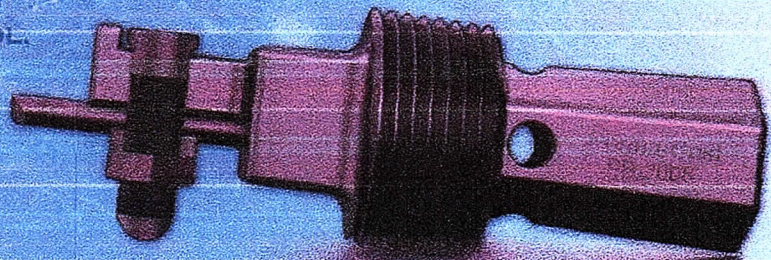

ACTUAL SIZE

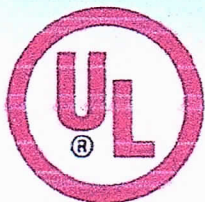

LISTED
40YZ

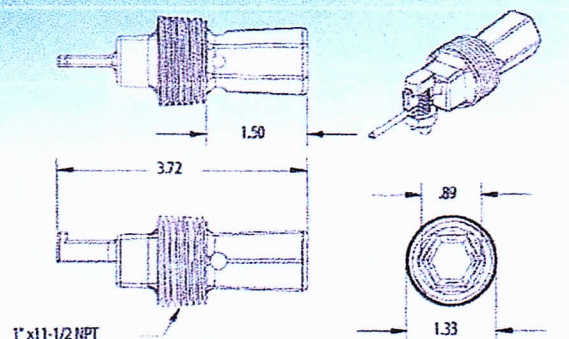

PATENT PENDING

Available Through Distribution Nationwide

1871 Aspen Circle • Pueblo, Colorado 81006 • Phone 800-748-2770 • Fax 719-544-3106
Vist Us At www.permacastonline.com



Middle Department Inspection Agency Inc.

3901 Hartzdale Dr Ste 112 Camp Hill, PA 17011
Tel: 717-761-5340 Fax: 717-761-5590

BASIC POOL WIRING REQUIREMENTS

1. A number 8 or larger solid copper wire bonding wire is required between all metallic parts of the pool structure, pump motor, and other metallic parts within 5 feet of the inside wall of the pool. Walls of a metal pool structure or the reinforcing steel of a concrete pool shall be used as the bonding grid. NEC Section 680.26
2. A 125 volt, 15 or 20-amp general purpose GFCI receptacle is required within 6 to 20 feet of the inside wall of pool. NEC Section 680.22 A3.
3. A single locking type 125 volt GFCI receptacle for the circulation and/or sanitation system is permitted – no less than 6 ft (1.83M) – from the inside wall of the pool with a weather tight “in-use” type cover. NEC Section 680.22 A1.
4. If the pump motor is hard wired, a disconnect switch is required at the motor, and must be GFCI protected. NEC 680.22B.
5. Wiring to the pump motor and associated equipment must be installed in electrical conduit with the minimum cover as required by table 680.10 of the NEC. (18 inches for 120 Volt in PVC conduit).
6. Wiring to the pump motor must be done with 3 conductors, including a green insulated ground wire, minimum size of number 12. NEC Section 680.21 A1.
7. U.F. type, direct burial wire, CANNOT be used for a pump motor circuit. NEC Section 680.21 A1.
8. Any of the wiring methods recognized in Chapter 3 of the ²⁰¹⁴ ~~2008~~ NEC shall be permitted to be used in the interior of one family dwelling units for the pump motor circuit, NEC 680.21 A4.
9. The flexible cord, if used for the pump motor, cannot exceed 3 ft in length, with number 12 bond wire. NEC Section 680.21 A5.
- 10 All electrical outlets (receptacle or direct connect) shall now be protected, including pool motors, with GFCI's. (120V or 240V) NEC 680 22(A)(4).
11. Perimeter surfaces with rebar or wire mesh shall be bonded in four uniformly spaced points around the perimeter of the pool. NEC 680.26B(2).
12. An intentional pool water bond must be a minimum of 9 sq inches shall be installed in direct contact with the water. NEC 680.26C. 2014
13. All pool wiring shall conform with Article 680 of the ~~2008~~ National Electric Code.

ABOVE GROUND POOL COMMON VIOLATIONS

Pool-associated motors shall be connected to an insulated copper equipment grounding conductor not smaller than 12 AWG. Where the branch circuit supplying the motor is installed in the interior of a one-family dwelling or in the interior of accessory buildings associated with a one-family dwelling, using a cable wiring method permitted by Table E4202.1 2009 International Residential Code

Receptacles that provide power for water-pump motors or other loads directly related to the circulation and sanitation system shall be permitted to be located between 6 feet and 10 feet from the inside walls of pools and outdoor spas and hot tubs, and, where so located, shall be single and of the locking and grounding type and shall be protected by ground-fault circuit interrupters. Other receptacles on the property shall be located not less than 6 feet from the inside walls of pools.

All 15- and 20-ampere, single phase, 125-volt receptacles located within 20 feet of the inside walls of pools shall be protected by a ground-fault circuit-interrupter. Outlets supplying pool pump motors from branch circuits with short-circuit and ground-fault protection rated 15 or 20 amperes, 125 volt or 240 volt, single phase, whether by receptacle or direct connection, shall be provided with ground-fault circuit-interrupter protection for personnel.

All metallic parts of the pool structure, including reinforcing metal shall be bonded.

The pool water shall be intentionally bonded by means of a conductive surface area not less than 9 square inches installed in contact with the pool water. This bond shall be permitted to consist of parts that are required to be bonded in Section E4204.2.

Requirements for barriers, fences, gates and locks are found in Appendix G of the ~~2009~~ ^{2015 IS PSC} International Residential Code.

permanent *residential* spas shall be controlled in accordance with the requirements of APSP 15.

SECTION 304 FLOOD HAZARD AREAS

304.1 General. The provisions of Section 304 shall control the design and construction of pools and spas installed in *flood hazard areas*.

[BS] 304.2 Determination of impacts based on location. Pools and spas located in *flood hazard areas* indicated within the *International Building Code* or the *International Residential Code* shall comply with Section 304.2.1 or 304.2.2.

Exception: Pools and spas located in riverine *flood hazard areas* that are outside of designated floodways and pools and spas located in *flood hazard areas* where the source of flooding is tides, storm surges or coastal storms.

[BS] 304.2.1 Pools and spas located in designated floodways. Where pools and spas are located in designated floodways, documentation shall be submitted to the code official that demonstrates that the construction of the pools and spas will not increase the design flood elevation at any point within the jurisdiction.

[BS] 304.2.2 Pools and spas located where floodways have not been designated. Where pools and spas are located where design flood elevations are specified but floodways have not been designated, the applicant shall provide a floodway analysis that demonstrates that the proposed pool or spa and any associated grading and filling, will not increase the design flood elevation more than 1 foot (305 mm) at any point within the jurisdiction.

[BS] 304.3 Pools and spas in coastal high-hazard areas. Pools and spas installed in coastal high-hazard areas shall be designed and constructed in accordance with ASCE 24.

[BS] 304.4 Protection of equipment. Equipment shall be elevated to or above the design flood elevation or be anchored to prevent flotation and protected to prevent water from entering or accumulating within the components during conditions of flooding.

304.5 GFCI protection. Electrical equipment installed below the design flood elevation shall be supplied by branch circuits that have ground-fault circuit interrupter protection for personnel.

SECTION 305 BARRIER REQUIREMENTS

305.1 General. The provisions of this section shall apply to the design of barriers for pools and spas. These design controls are intended to provide protection against the potential drowning and near drowning by restricting access to such pools or spas. These requirements provide an integrated level of protection against potential drowning through the use of physical barriers and warning devices.

Exceptions:

1. Spas and hot tubs with a lockable *safety cover* that complies with ASTM F 1346.

2. Swimming pools with a powered *safety cover* that complies with ASTM F 1346.

305.2 Outdoor swimming pools and spas. Outdoor pools and spas and indoor swimming pools shall be surrounded by a barrier that complies with Sections 305.2.1 through 305.7.

305.2.1 Barrier height and clearances. Barrier heights and clearances shall be in accordance with all of the following:

1. The top of the barrier shall be not less than 48 inches (1219 mm) above grade where measured on the side of the barrier that faces away from the pool or spa. Such height shall exist around the entire perimeter of the barrier and for a distance of 3 feet (914 mm) measured horizontally from the outside of the required barrier.
2. The vertical clearance between grade and the bottom of the barrier shall not exceed 2 inches (51 mm) for grade surfaces that are not solid, such as grass or gravel, where measured on the side of the barrier that faces away from the pool or spa.
3. The vertical clearance between a surface below the barrier to a solid surface, such as concrete, and the bottom of the required barrier shall not exceed 4 inches (102 mm) where measured on the side of the required barrier that faces away from the pool or spa.
4. Where the top of the pool or spa structure is above grade, the barrier shall be installed on grade or shall be mounted on top of the pool or spa structure. Where the barrier is mounted on the top of the pool or spa, the vertical clearance between the top of the pool or spa and the bottom of the barrier shall not exceed 4 inches (102 mm).

305.2.2 Openings. Openings in the barrier shall not allow passage of a 4-inch-diameter (102 mm) sphere.

305.2.3 Solid barrier surfaces. Solid barriers that do not have openings shall not contain indentations or protrusions that form handholds and footholds, except for normal construction tolerances and tooled masonry joints.

305.2.4 Mesh fence as a barrier. Mesh fences, other than chain link fences in accordance with Section 305.2.7, shall be installed in accordance with the manufacturer's instructions and shall comply with the following:

1. The bottom of the mesh fence shall be not more than 1 inch (25 mm) above the deck or installed surface or grade.
2. The maximum vertical clearance from the bottom of the mesh fence and the solid surface shall not permit the fence to be lifted more than 4 inches (102 mm) from grade or decking.
3. The fence shall be designed and constructed so that it does not allow passage of a 4-inch (102 mm) sphere under any mesh panel. The maximum vertical clearance from the bottom of the mesh fence and the solid surface shall not be more than 4 inches (102 mm) from grade or decking.

4. An attachment device shall attach each barrier section at a height not lower than 45 inches (1143 mm) above grade. Common attachment devices include, but are not limited to, devices that provide the security equal to or greater than that of a hook-and-eye-type latch incorporating a spring-actuated retaining lever such as a safety gate hook.
5. Where a hinged gate is used with a mesh fence, the gate shall comply with Section 305.3.
6. Patio deck sleeves such as vertical post receptacles that are placed inside the patio surface shall be of a nonconductive material.
7. Mesh fences shall not be installed on top of onground residential pools.

305.2.5 Closely spaced horizontal members. Where the barrier is composed of horizontal and vertical members and the distance between the tops of the horizontal members is less than 45 inches (1143 mm), the horizontal members shall be located on the pool or spa side of the fence. Spacing between vertical members shall not exceed $1\frac{3}{4}$ inches (44 mm) in width. Where there are decorative cutouts within vertical members, spacing within the cutouts shall not exceed $1\frac{3}{4}$ inches (44 mm) in width.

305.2.6 Widely spaced horizontal members. Where the barrier is composed of horizontal and vertical members and the distance between the tops of the horizontal members is 45 inches (1143 mm) or more, spacing between vertical members shall not exceed 4 inches (102 mm). Where there are decorative cutouts within vertical members, the interior width of the cutouts shall not exceed $1\frac{3}{4}$ inches (44 mm).

305.2.7 Chain link dimensions. The maximum opening formed by a chain link fence shall be not more than $1\frac{3}{4}$ inches (44 mm). Where the fence is provided with slats fastened at the top and bottom which reduce the openings, such openings shall be not more than $1\frac{3}{4}$ inches (44 mm).

305.2.8 Diagonal members. Where the barrier is composed of diagonal members, the maximum opening formed by the diagonal members shall be not more than $1\frac{3}{4}$ inches (44 mm). The angle of diagonal members shall be not greater than 45 degrees (0.79 rad) from vertical.

305.2.9 Clear zone. There shall be a clear zone of not less than 36 inches (914 mm) between the exterior of the barrier and any permanent structures or equipment such as pumps, filters and heaters that can be used to climb the barrier.

305.2.10 Poolside barrier setbacks. The pool or spa side of the required barrier shall be not less than 20 inches (508 mm) from the water's edge.

305.3 Gates. Access gates shall comply with the requirements of Sections 305.3.1 through 305.3.3 and shall be equipped to accommodate a locking device. Pedestrian access gates shall open outward away from the pool or spa, shall be self-closing and shall have a self-latching device.

305.3.1 Utility or service gates. Gates not intended for pedestrian use, such as utility or service gates, shall remain locked when not in use.

305.3.2 Double or multiple gates. Double gates or multiple gates shall have at least one leaf secured in place and the adjacent leaf shall be secured with a self-latching device. The gate and barrier shall not have openings larger than $\frac{1}{2}$ inch (12.7 mm) within 18 inches (457 mm) of the latch release mechanism. The self-latching device shall comply with the requirements of Section 305.3.3.

305.3.3 Latches. Where the release mechanism of the self-latching device is located less than 54 inches (1372 mm) from grade, the release mechanism shall be located on the pool or spa side of the gate not less than 3 inches (76 mm) below the top of the gate, and the gate and barrier shall not have openings greater than $\frac{1}{2}$ inch (12.7 mm) within 18 inches (457 mm) of the release mechanism.

305.4 Structure wall as a barrier. Where a wall of a dwelling or structure serves as part of the barrier and where doors or windows provide direct access to the pool or spa through that wall, one of the following shall be required:

1. Operable windows having a sill height of less than 48 inches (1219 mm) above the indoor finished floor and doors shall have an alarm that produces an audible warning when the window, door or their screens are opened. The alarm shall be *listed* and *labeled* as a water hazard entrance alarm in accordance with UL 2017. In dwellings or structures not required to be Accessible units, Type A units or Type B units, the operable parts of the alarm deactivation switches shall be located 54 inches (1372 mm) or more above the finished floor. In dwellings or structures required to be Accessible units, Type A units or Type B units, the operable parts of the alarm deactivation switches shall be located not greater than 54 inches (1372 mm) and not less than 48 inches (1219 mm) above the finished floor.
2. A *safety cover* that is *listed* and *labeled* in accordance with ASTM F 1346 is installed for the pools and spas.
3. An *approved* means of protection, such as self-closing doors with self-latching devices, is provided. Such means of protection shall provide a degree of protection that is not less than the protection afforded by Item 1 or 2.

305.5 Onground residential pool structure as a barrier. An onground residential pool wall structure or a barrier mounted on top of an onground residential pool wall structure shall serve as a barrier where all of the following conditions are present:

1. Where only the pool wall serves as the barrier, the bottom of the wall is on grade, the top of the wall is not less than 48 inches (1219 mm) above grade for the entire perimeter of the pool, the wall complies with the requirements of Section 305.2 and the pool manufacturer allows the wall to serve as a barrier.

2. Where a barrier is mounted on top of the pool wall, the top of the barrier is not less than 48 inches (1219 mm) above grade for the entire perimeter of the pool, and the wall and the barrier on top of the wall comply with the requirements of Section 305.2.
3. Ladders or steps used as means of access to the pool are capable of being secured, locked or removed to prevent access except where the ladder or steps are surrounded by a barrier that meets the requirements of Section 305.
4. Openings created by the securing, locking or removal of ladders and steps do not allow the passage of a 4-inch (102 mm) diameter sphere.
5. Barriers that are mounted on top of onground residential pool walls are installed in accordance with the pool manufacturer's instructions.

305.6 Natural barriers. In the case where the pool or spa area abuts the edge of a lake or other natural body of water, public access is not permitted or allowed along the shoreline, and required barriers extend to and beyond the water's edge not less than 18 inches (457 mm), a barrier is not required between the natural body of water shoreline and the pool or spa.

305.7 Natural topography. Natural topography that prevents direct access to the pool or spa area shall include but not be limited to mountains and natural rock formations. A natural barrier approved by the governing body shall be acceptable provided that the degree of protection is not less than the protection afforded by the requirements of Sections 305.2 through 305.5.

SECTION 306 DECKS

306.1 General. Decks shall be designed and installed in accordance with the *International Residential Code* or the *International Building Code*, as applicable in accordance with Section 102.7.1, except as provided in this section.

306.2 Slip resistant. Decks, ramps, coping, and similar step surfaces shall be slip resistant and cleanable. Special features in or on decks such as markers, brand insignias, and similar materials shall be slip resistant.

306.3 Step risers and treads. Step risers for decks of public pools and spas shall be uniform and have a height not less

than $3\frac{3}{4}$ inches (95 mm) and not greater than $7\frac{1}{2}$ inches (191 mm). The tread distance from front to back shall be not less than 11 inches (279 mm). Step risers for decks of residential pools and spas shall be uniform and shall have a height not exceeding $7\frac{1}{2}$ inches (191 mm). The tread distance from front to back shall be not less than 10 inches (254 mm).

306.4 Deck steps handrail required. Public pool and spa deck steps having three or more risers shall be provided with a handrail.

306.5 Slope. The minimum slope of decks shall be in accordance with Table 306.5 except where an alternative drainage method is provided that prevents the accumulation or pooling of water. The slope for decks, other than wood decks, shall be not greater than $\frac{1}{2}$ inch per foot (1 mm per 24 mm) except for ramps. The slope for wood and wood/plastic composite decks shall be not greater than $\frac{1}{4}$ inch per 1 foot (1 mm per 48 mm). Decks shall be sloped so that standing water will not be deeper than $\frac{1}{8}$ inch (3.2 mm), 20 minutes after the cessation of the addition of water to the deck.

306.6 Gaps. Gaps shall be provided between deck boards in wood and wood/plastic composite decks. Gaps shall be consistent with approved engineering methods with respect to the type of wood used and shall not cause a tripping hazard.

306.6.1 Maximum gap. The open gap between pool decks and adjoining decks or walkways, including joint material, shall be not greater than $\frac{3}{4}$ inch (19.1 mm). The difference in vertical elevation between the pool deck and the adjoining sidewalk shall be not greater than $\frac{1}{2}$ inch (6.4 mm).

306.7 Concrete joints. Isolation joints that occur where the pool coping meets the concrete deck shall be water tight.

306.7.1 Joints at coping. Joints that occur where the pool coping meets the concrete deck shall be installed to protect the coping and its mortar bed from damage as a result of the anticipated movement of adjoining deck.

306.7.2 Crack control. Joints in a deck shall be provided to minimize visible cracks outside of the control joints caused by imposed stresses or movement of the slab.

306.7.3 Movement control. Areas where decks join existing concrete work shall be provided with a joint to protect the pool from damage caused by relative movement.

306.8 Deck edges. The edges of decks shall be radiused, tapered, or otherwise designed to eliminate sharp corners.

TABLE 306.5
MINIMUM DRAINAGE SLOPES FOR DECK SURFACES

SURFACE	MINIMUM DRAINAGE SLOPE (INCH PER FOOT)
Carpet	$\frac{1}{2}$
Exposed aggregate	$\frac{1}{4}$
Textured, hand-finished concrete	$\frac{1}{5}$
Travertine/brick-set pavers, public pools or spas	$\frac{3}{8}$
Travertine/brick-set pavers, residential pools or spas	$\frac{1}{8}$
Wood	$\frac{1}{8}$
Wood/plastic composite	$\frac{1}{8}$

For SI: 1 inch = 25.4 mm, 1 foot = 304.8 mm.

POOL BARRIER REQUIREMENTS

Removable pool ladder may serve as a barrier if the pool sides are a minimum of 48" above finished grade.

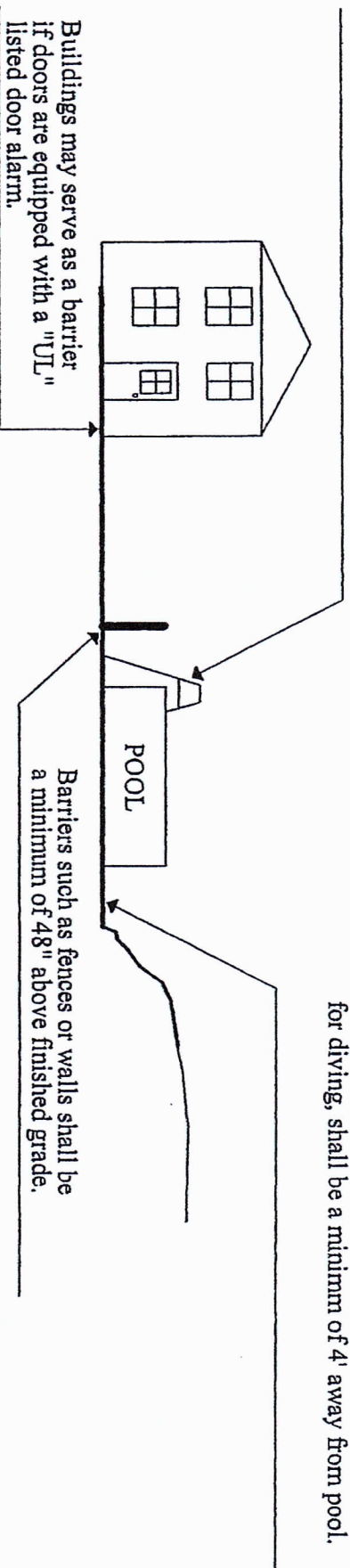

Features such as banks, walls, etc., that can be used for diving, shall be a minimum of 4' away from pool.

Buildings may serve as a barrier if doors are equipped with a "UL" listed door alarm.

Barriers such as fences or walls shall be a minimum of 48" above finished grade.

Latch may be located on the inside or outside of the gate if is 54" minimum above finished grade

If latch is less than 54" above finished grade, latch shall be located on the inside, 3" below top, and no opening greater than 1/2" shall be located within 18" of latch.

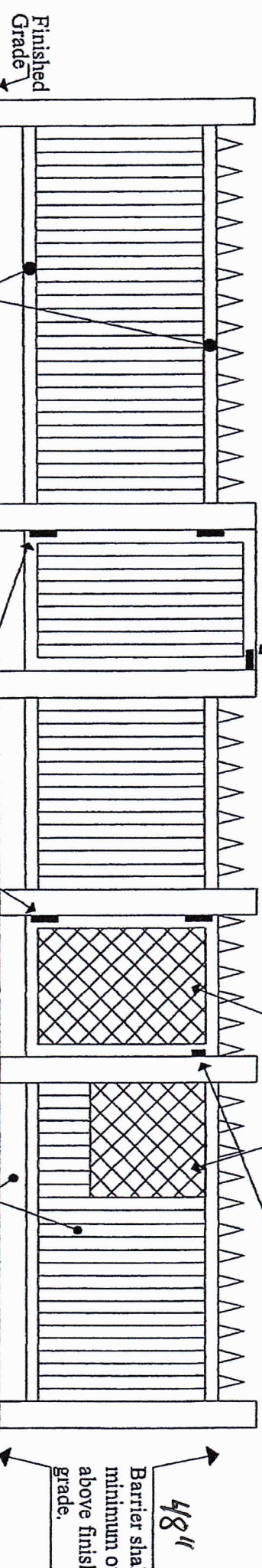

Horizontal members shall be 4 5/8" apart or located on the pool side of the fence.

Gates shall have self-closing hardware and open outward

Spaces between members shall not allow the passage of a 4" sphere.

48"
Barrier shall be a minimum of 48" above finished grade.